

ESDEC

INNOVATIVE MOUNTING SYSTEMS



**RELIABLE AND
QUICK
INSTALLATION ON
PITCHED ROOFS**

CLICKFIT EVO

STEEL ROOF

THE 4 BASIC COMPONENTS OF CLICKFIT EVO

BASIC



Portrait



Landscape



1.1 BASIC MOUNTING

- Low mounting profile 'Basic'
- Positioned close to roof
- System contains 4 components

1 Suitable for corrugated steel roof in combination with additional adapter profile

OR

OPTIMIZER-READY



Portrait



Landscape



1.2 MOUNTING WITH OPTIMIZER

- High mounting profile 'Optimizer-ready'
- When installing large optimizer
- System contains 4 components

2 Suitable for corrugated steel roof in combination with additional adapter profile



2. SELF-TAPPING SCREWS

- Self-tapping screws, so no need for pre-drilling
- Mounting with a single tool
- Multi head screw T30 and SW10
- Installation with rivets possible



3. UNIVERSAL MODULE CLAMP

- Universal module clamp: suitable for all framed solar panels
- To be used as central clamp and terminal clamp (combined with end clamp support)
- Pre-assembled as standard
- Including solar panel equalisation
- Available in grey and black

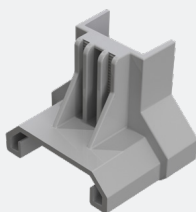

4. END CLAMP SUPPORT

- End clamp support for good end clamp functionality
- Available in grey and black

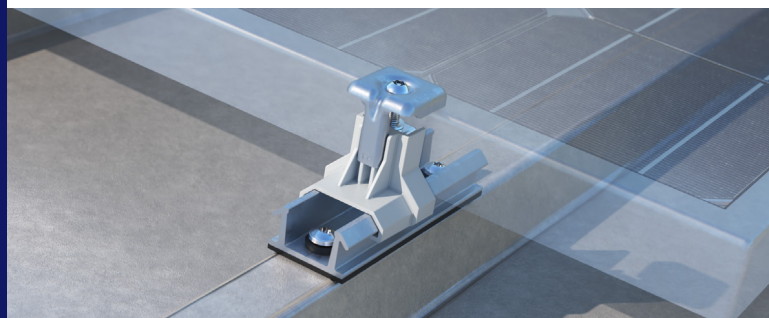
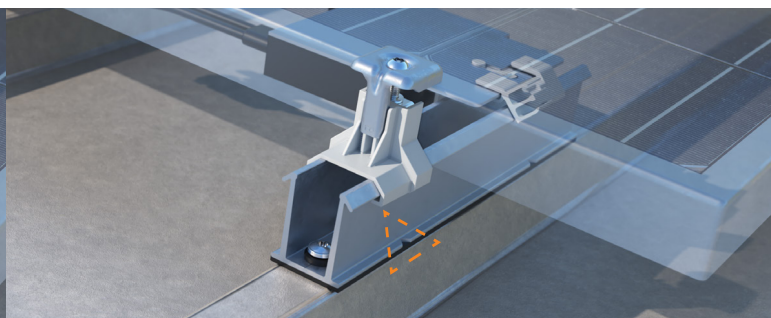
**BASIC MOUNTING PROFILE**
POSITIONED CLOSE TO ROOF**OPTIMIZER-READY MOUNTING PROFILE**
WHEN INSTALLING LARGE OPTIMIZER

EXCEPTIONALLY EASY TO MOUNT

ClickFit EVO Steel Roof: universal, fast and flexible

ClickFit EVO Steel Roof has been specially developed for the solar installer. The system is clear and simple, consisting of just four components. ClickFit EVO Steel Roof is suitable for all common solar panels and any type of steel roof. Thanks to its unique universal properties, the system is very flexible and quick to mount.

Compact mounting profiles including adapter profile

The compact ClickFit EVO Steel Roof mounting profiles have pre-punched holes and pre-glued EPDM rubber seals, saving you a lot of preparation. The Optimizer-ready profile (landscape) has a notch, allowing you to easily align it to the roof. This eliminates the need to apply corrections during installation. You can choose between low and high mounting profiles:

- The low 'Basic' mounting profile allows you to position the solar panels close to the roof.
- With the high 'Optimizer-ready' mounting profile, there is enough free space left to fit all the available large optimizers to be mounted under the panels.

For trapezoidal and corrugated steel roofs

ClickFit EVO Steel Roof mounting profiles are suitable for all types of trapezoidal and corrugated steel roofs (for landscape, in combination with the adapter profile). You install the mounting profiles directly on a trapezoidal or corrugated steel roof, either vertically for landscape orientation or horizontally for portrait orientation. The EPDM rubber elements on the profiles provide guaranteed water tightness. You mount the profiles using the self-tapping screw, without any need for drilling. You can also mount the profiles using blind rivets by first drilling 6.5 mm holes. This application is also many times lighter than a rail system. The 'optimizer-ready' mounting profile is suitable for placing large optimizers beneath the panel.

Non-standard steel profile roofs: roof mounting with hanger bolt

On other types of steel roofs, such as steel tile roofing sheets, you simply mount ClickFit EVO to the roof using a hanger bolt. The ClickFit EVO Hanger Bolt is delivered ready-assembled and the flexible adapter allows you to easily and quickly compensate for roof irregularities of up to 10 degrees. Using the universal ClickFit EVO fitted to the hanger bolt as standard, you can simply carry on working with familiar components from the ClickFit EVO product line, such as universal rails, module clamps and end caps. As well as being suitable for steel roofs, this hanger bolt can also be used on corrugated, EPDM, bitumen and Arabic tiles.

ADVANTAGES FOR THE INSTALLER

- ✓ Choice of low/high mounting profiles or the hanger bolt
- ✓ Only four components on the roof
- ✓ Only one tool needed
- ✓ Optional: adapter profile for corrugated steel roof
- ✓ 20-year product warranty

ADVANTAGES FOR THE END USER

- ✓ The roof stays intact
- ✓ For mounting profiles: no unnecessary drilling
- ✓ Aesthetic design, also available in black
- ✓ Extensively tested product
- ✓ 20-year product warranty

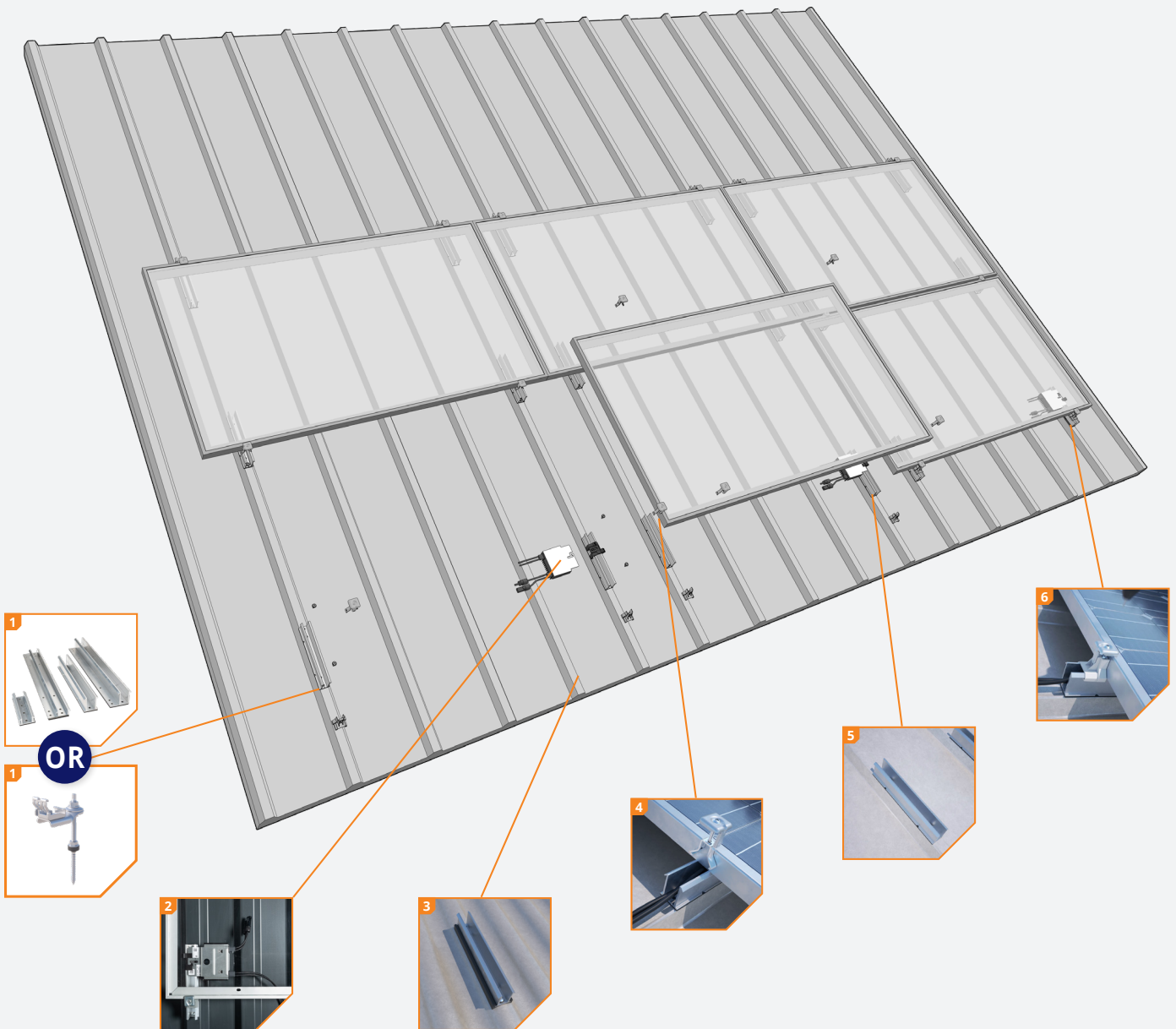

1 Choice of four mounting profiles or the hanger bolt

Four different mounting profile types for trapezoidal or corrugated steel roofs:

- Low mounting profile (Basic): portrait or landscape
- High mounting profile (Optimizer ready): portrait or landscape

On other types of steel roof, the hanger bolt provides the ideal solution for using ClickFit EVO as your mounting system for solar panels. The integrated click connection allows you to click universal rails onto the roof in a flash. Then, use the universal module clamp and end caps to clamp the solar panel to the roof.

2 Fitting optimizer

The high 'Optimizer-ready' mounting profile provides sufficient space for all available large optimizers.

3 Suitable for corrugated steel roof

In combination with the adapter profile, the landscape mounting profiles are also suitable for corrugated steel roofs.

4 Universal module clamp

The universal module clamp is suitable for all framed solar panels. To be used as central clamp or terminal clamp (combined with end clamp support).







5 Mounting profiles with rubber seals

Short mounting profiles including EPDM rubber layer.

6 Just 4 components



Only 4 components are required to install ClickFit EVO Steel Roof.

MOUNTING PROFILE & FIXING



-  ClickFit EVO Steel roof mounting profile 'Basic' landscape 1008048
-  ClickFit EVO Steel roof mounting profile 'Basic' portrait 1008049
-  ClickFit EVO Steel roof mounting profile 'Optimizer-ready' landscape 1008050
-  ClickFit EVO Steel roof mounting profile 'Optimizer-ready' portrait 1008051
-  ClickFit EVO Self-tapping screw 6,0x25 mm SW10 HEX/T30 1008085
-  ClickFit EVO Rivet 1008087

OR







STOKSCHROEF

-  ClickFit EVO Hanger Bolt
 - M10x200mm 1008011
 - M10x250mm 1008012
 - M12x250mm 1008013
 - M12x300mm 1008014
 - M12x350mm 1008015 [DTO]
-  ClickFit EVO Mounting Rail
 - Mounting Rail 1188mm 1008131
 - Mounting Rail 2338mm 1008132
 - Mounting Rail 3488mm 1008133
 - Mounting Rail 3500mm 1008007
 - Mounting Rail 4638mm 1008134
 - Mounting Rail 5770mm 1008135

MODULECLAMP & END CAP

-  ClickFit EVO Module Clamp Universal grey 1008020
-  ClickFit EVO Module Clamp Universal black 1008020-B
-  ClickFit EVO Mounting rail End cap grey 1008060
-  ClickFit EVO Mounting rail End cap black 1008060-B
-  ClickFit EVO End Cap without end clamp support grey 1008066
-  ClickFit EVO End Cap without end clamp support black 1008066-B
-  ClickFit EVO End Clamp Support grey 1008065
-  ClickFit EVO End Clamp Support black 1008065-B

ACCESSOIRES

-  ClickFit EVO Mounting Rail Connector Piece 1008061
-  ClickFit EVO Mounting Rail Cable clip optimizer ready 1008062
-  ClickFit EVO Auxiliary set with cable clip 1008064
-  ClickFit EVO Bit torx 30 1008069
-  ClickFit EVO EPDM adapter profile corrugated steel roof 'Basic' landscape 1008081
-  ClickFit EVO EPDM adapter profile corrugated steel roof 'Optimizer-ready' landscape 1008082

Calculator

In the Esdec calculator you can manage and calculate all your projects, for both pitched and flat roofs. One platform with all Esdec mounting systems for the most reliable calculation of your project.

- ✔ Save time: manage all your projects on one platform
- ✔ One calculator for projects on pitched and flat roofs
- ✔ All calculations are based on extensive testing and the latest safety standards

Unlimited calculations: use the calculator for your own project calculations without limits on the roof height. The calculator also takes into account the terrain category, snow load and wind zone to provide accurate advice, specific to your project.

Go to eu.esdec.com/en/calculator



Warranty

ClickFit EVO meets all of the requirements and standards that currently apply. ClickFit EVO comes with a unique 20-year product warranty, thus ensuring the system's quality.

- ✔ Use of premium high tech materials
- ✔ Extensively tested
- ✔ BDA/KIWA certification
- ✔ 20 years' product warranty





05 | 02 | 2022

BUILDING VALUE FOR SOLAR PROFESSIONALS

Esdec

Londenstraat 16
7418 EE Deventer
The Netherlands

 +31 850 702 000
 info@esdec.com